



GW*i*
SERIES 5000

VS



THE PERFECT THREAD

CUSTOMER BENEFITS

- Process security
- Threads without burrs
- Required tolerance respected
- Better chip evacuation
- 3xD Threading depth
- Internal coolant
- High productivity
- Improved performance



nano

www.dcswiss.com

ABSTRACT

The industry demands more and more perfection in threading than ever before. Requirement of a perfect thread is machining the burr free complete profile but unfortunately there was no tool available in the market to fulfill this most important requirement.

Our objective was to develop a tool based on GW series which will produce threads without any burr. The tool cuts the flanks of the thread along with the core hole diameter.

For a perfect thread, a perfect hole is required. Hence DC Swiss also recommends a centre and spiral drill.

FEATURES

The ultrafine grade carbide tool coated with VS coating provides excellent heat resistance which is an ideal combination for a high performance machining.

CYCLE OF MILLING

Counter clockwise rotation. Tool left hand cut. Feed only on one tooth. Internal coolant recommended for best chip evacuation.

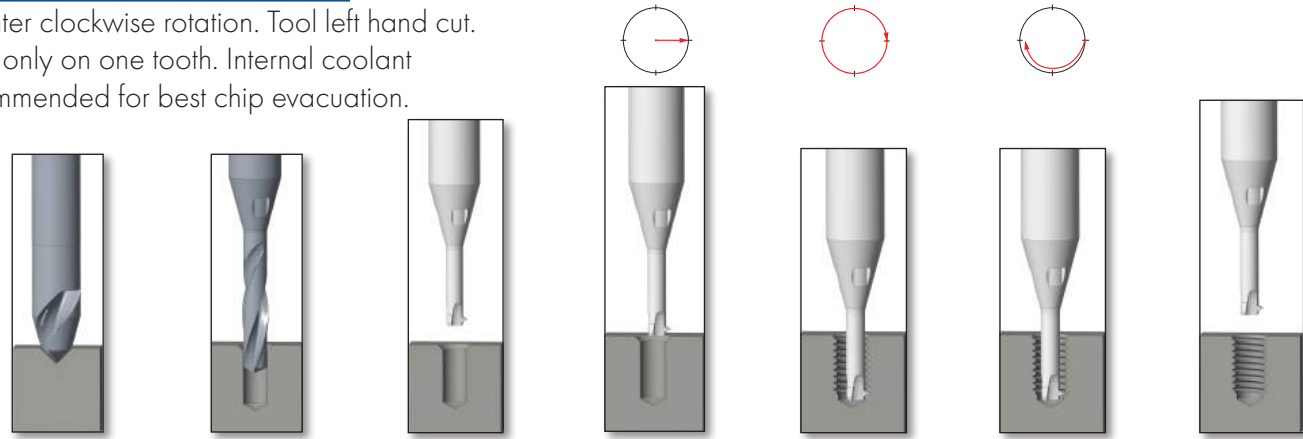

PRODUCT LINE



GWi5066VS GWi5067VS

in stock delivering in 4 weeks

$\varnothing D_1$ M	P mm	d_1 mm	l_1 mm	$l_{2,5xD}$ mm	$l_{3,3xD}$ mm	$d_2 h_6$ mm		ID	ID
0.8	0.200	0.55	40	2.3	2.7	3	1	189165	
0.9	0.225	0.62	40	2.6	3.1	3	1	189166	
1.0	0.250	0.66	40	2.9	3.4	3	1	189167	
1.2	0.250	0.86	40	3.4	4.0	3	1	189168	
1.4	0.300	1.03	40	4.0	4.7	4	1	189169	189174
1.6	0.350	1.16	40	4.6	5.4	4	1	189170	189175
1.8	0.350	1.36	40	5.1	6.0	4	1	189171	189176
2.0	0.400	1.50	40	5.6	6.6	4	1	189172	189177
2.5	0.450	1.94	40	7.0	8.2	4	1	189173	189178

other dimensions on demand

FZ315VS

Drill diam. mm	ID	Center diam. mm	ID
0.58	182863	1.40	182872
0.65	182864	2.00	182873
0.70	182865	3.00	182874
0.90	182866		
1.05	182867		
1.19	182868		
1.39	182869		
1.54	182870		
1.98	182871		

www.dcswiss.com

APPLICATION

Material: Titan grade 4
Machine: Tornos Evo Deco
Typ of hole: Blind hole
Thread size: M1.8 6H
Thread length: 2xD
Lubricant: Cutting oil
Vc & Feed: 30 m/min & 0.03 mm/tooth

INDUSTRIES

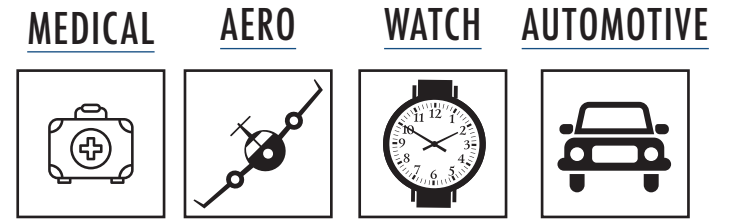

NUMBER OF NC – CORRECTION GWi5000: 1 TIME
NUMBER OF NC – CORRECTION COMPETITOR: 5 TIMES

AFTER 2500 THREADS

GWi5066VS M1.8x0.35

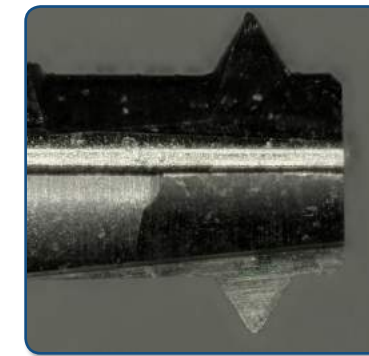
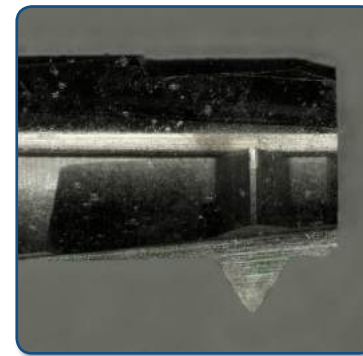

GWi5066VS M1.8x0.35
details

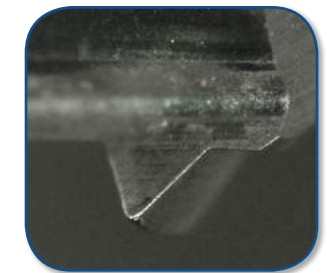

COMPETITOR

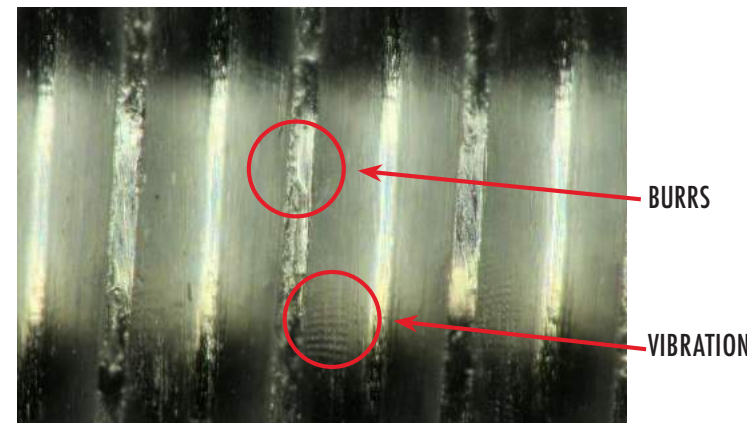

PERFECT THREAD

GWi5066VS M1.8x0.35

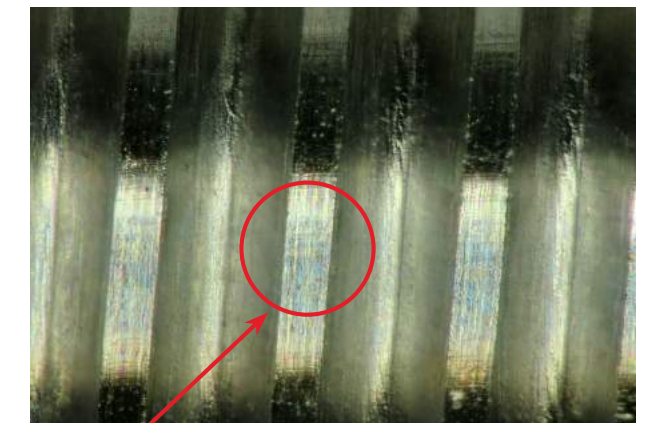

www.dcswiss.com

nano

THREAD CUTTING



nano

THREAD FORMING



nano

THREAD WHIRL CUTTER



nano

SOFT RIGID TAPPING



nano

THREAD GAUGES



nano

GW1 SERIES



DC SWISS SA

CH-2735 Malleray

Tel. +41 32 491 63 63

Fax +41 32 491 64 64

E-mail: info@dcswiss.ch

